

4th Gen Modular Multi-Scene Handheld Inkjet Printer



1+N Multi-Functional Integrated Modules

Supports All Printing Tasks



5-Inch
HD Touch Screen

HD
1280 X 720



3000mAh
Replaceable
Battery







2 Print Size
Models Available

Max Length: 600mm

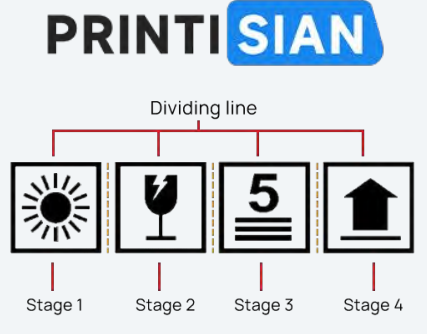
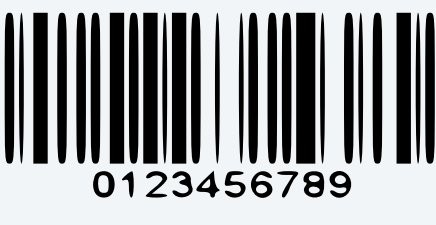
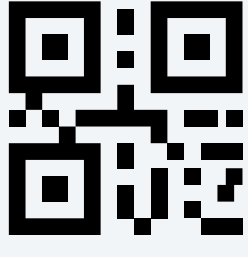



Intelligent Custom Printing Content

<p>MFD:09/09/2022 EXP:09/09/2023</p> <p>Production Date</p>	<p>MFD:09-09-2022 EXP:09-09-2023</p> <p>Bitmap Fonts</p>	<p>PRINTISIAN printisian printisian</p> <p>Custom Fonts</p>	<p>TXT</p> <p>Text</p>	<p>A000-1 A000-2 A000-3</p> <p>Serial Number</p>							
 <p>Logo / Trademark</p>	 <p>Barcode</p>	 <p>QR Code</p>	 <p>Graphics</p>	<table border="1"> <tr> <td>Item</td> <td>DELLOLED</td> <td rowspan="3"></td> </tr> <tr> <td>Batch No</td> <td>230721-B</td> </tr> <tr> <td>SN</td> <td>001-08958</td> </tr> </table> <p>Form Files</p>	Item	DELLOLED		Batch No	230721-B	SN	001-08958
Item	DELLOLED										
Batch No	230721-B										
SN	001-08958										

Print On Virtually Anything





Print on Any Surface

Smooth, Rough, Narrow...







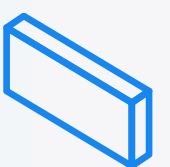

Print on Any Shape

Round, Curved Surface, Thin Edge...

Print on Any Material

Paper, Glass, Cardboard, Plastic, Metal, Wood, Concrete, Cable, Wheel, Leather...

Flexible Modular Design

Freely Swap 5 Adapters For Unlimited Possibilities

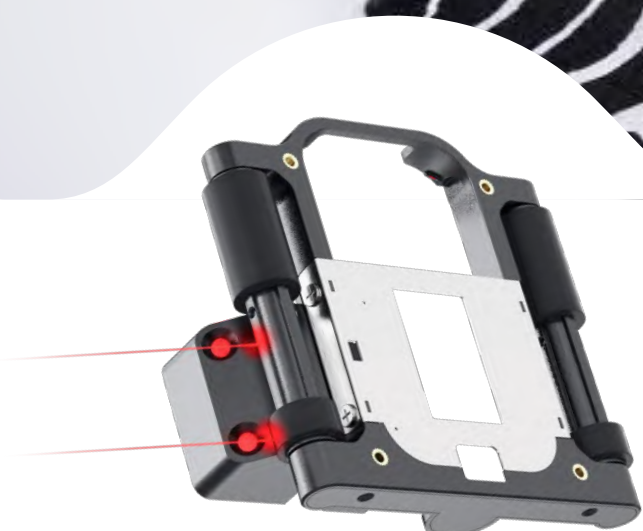

Laser Alignment Clip

The laser aligner greatly improves positioning accuracy, efficiency & consistency for maximum productivity

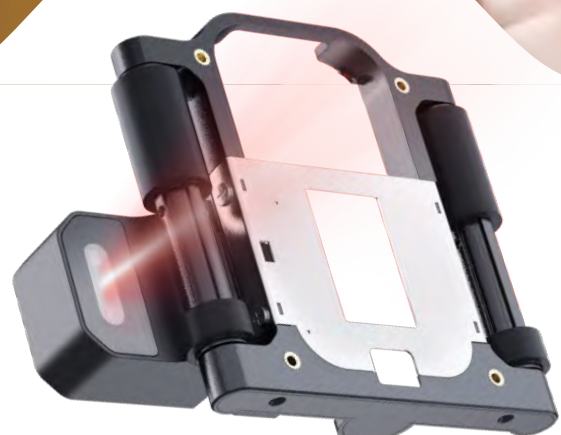

Scanner Clip

Scan to import barcodes & QR codes for direct printing. Instant code reading streamlines operations from checkout scanning to backend inventory management

Assembly Line Clip

Automatic trigger printing upon production line detection. Saves wiring & debugging, convenient & efficient



Pipe Clip

Adjustable dual-wheel spacing for stable printing on various pipe diameters. Enables traceability for all construction & woodworking applications



Edge Position Clip

Automatic trigger printing upon production line detection. Saves wiring & debugging, convenient & efficient



One-Step Printing Method

Finished Easily In 3 Simple Steps

Method 1: Finish Printing In 3 Easy Steps

Design



Tap



Swipe



Method 2: Touch-Free Printing

Built-in sensor enables printing without tapping any buttons



Applicable Industries

Delivering Brand-New Experience For All Industries

Packaging Industry

Create industry labels to facilitate traceability & packaging management

Industrial Production

Portable handheld inkjet printer, unrestricted site usage. Improves material management efficiency for hard-to-transport materials

Creative Studio

DIY custom exclusive labels & bring extraordinary creativity to life

Daily Necessities Industry

Flexible & efficient, compatible with multi-category products

80m / Min

Fast & Efficient Printing Speed

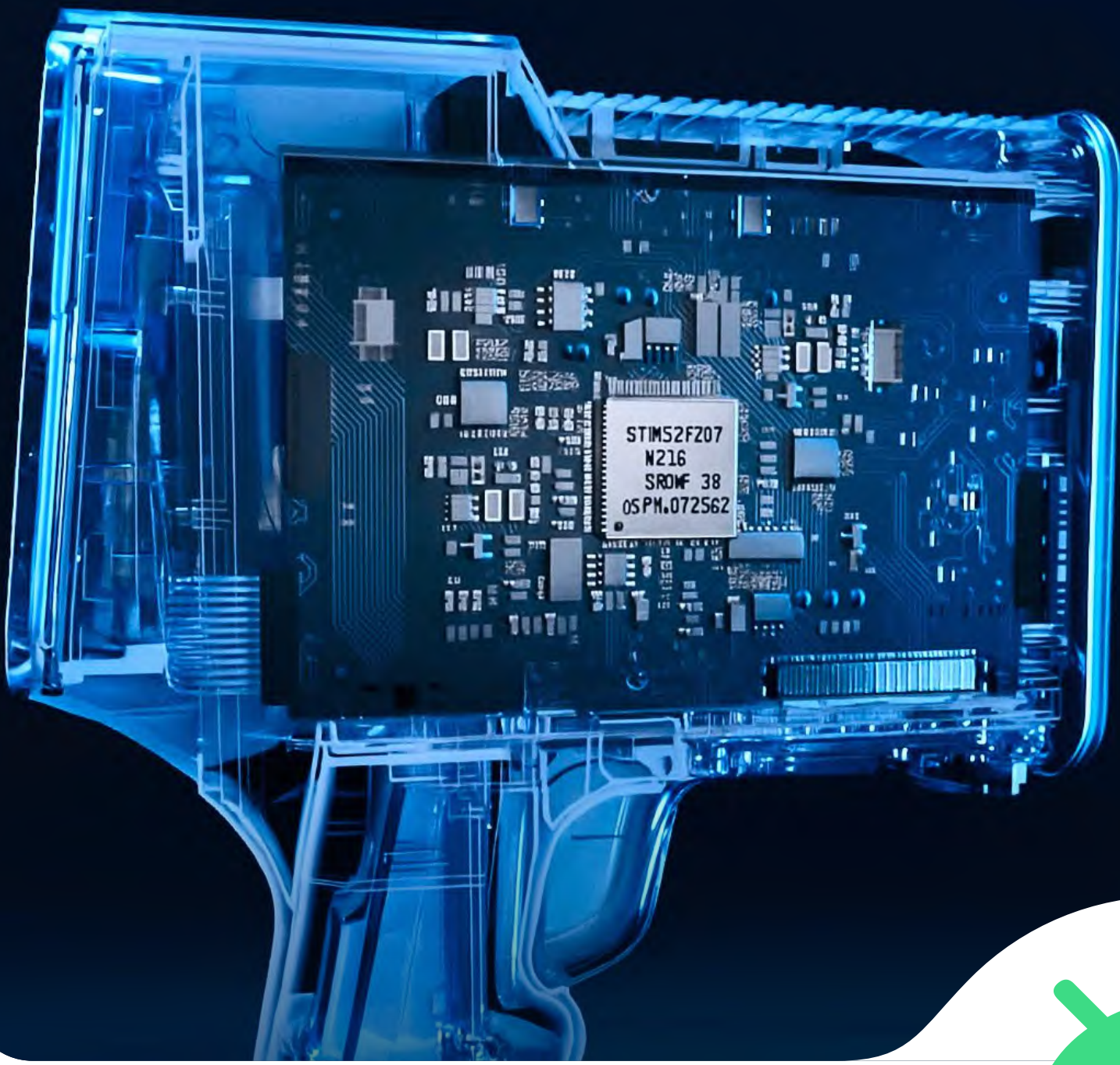

30%

Average Response Rate

47%

Printing Speed for Complex Tasks



1GB

RAM

8GB

ROM



Print OS Supported by Android

Multi-Language Support

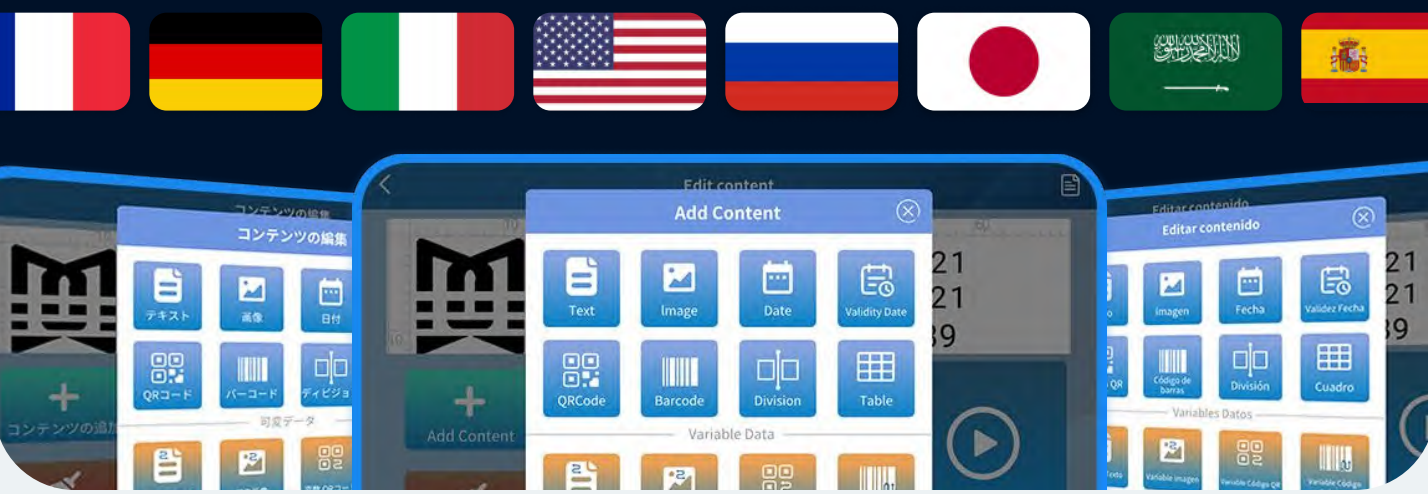

Import Any Keyboard Input Method



Font Settings



Built-in Multiple Fonts



Import Custom Fonts

Efficient Large-Scale Graphic & Text Printing

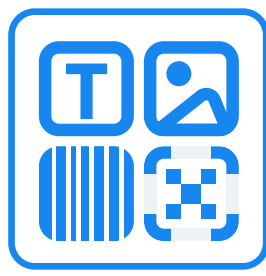

Stored Print Task



Retain Information Editing Module



Ink Cartridge Quick Selection



Size Selection

Ink Type

Color Selection

Invisible Color

Size Selection

0.5" (12.7mm)

1" (25.4mm)

Ink Type

Solvent Type

Aqueous Type



42ml

Print Height
0.5 inch
(12.7mm)



45ml

Print Height
1 inch
(25.4mm)



Ink Cartridge Print Effect



600 DPI
Sharp & Clear
Edges

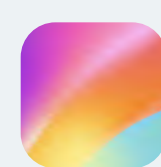

Excellent Detail
Restoration & Natural
Color Transition

Product Specification Data Sheet

Handheld Inkjet Printer Parameters

Size	5.7x2x8.85inch (LxWxH 14.5x5.3x22.5cm)
Weight	18oz (512g)
Display Screen	5-Inch IPS LCD Touch Display Screen
Material	ABS
USB	Type-C / USB-A
Printing Method	Buttons / Sensors
Battery	3000 mAh 10 Hrs(Continuous use)
Charger	5V/2A
Max Single Printing Length	0.07-39.3inch(2-1000mm)
Operating Environment	Temperature: 0°C to 40°C (32°F to 104°F) Humidity: 10%-80%
Printing Content	Text / QR Code / Barcode / Date / Graphics / Tables / Segmented Printing / Variable Text / Variable Images / Variable QR Code / Variable Barcode
Language Support	

Ink Cartridge Parameters

Color	Black, Red, Blue, Yellow, Purple
Weight	0.5-Inch Cartridge: 3.9oz (113g) 1-Inch Cartridge: 4.7oz (135g)
Resolution	0.5-Inch Cartridge: 300-600 DPI 1-Inch Cartridge: 300 DPI
Single Print Height	0.5-Inch Cartridge: 0.07-0.5in (2-12.7mm) 1-Inch Cartridge: 0.07-1in (2-25.4mm)
Printing Distance	0.07-0.19inch(2-5mm)
Print Yield Per Cartridge	1531yd(1400m) or 5000 Pages (5% Coverage)
Printable Materials	Wood, Carton, Pipe, Plastic Bag, Aluminum Foil Bag, Ceramic, Glass, Metal, Stone, Building Materials & More
Operating Environment	Temperature: 0°C To 40°C (32°F To 104°F) Humidity: 10%-80%



Net Weight Of Aluminum Case: **56.4 oz** (1.6Kg)

(Outer Material: Aluminum Alloy Frame; Inner Material: EVA Foam)

Aluminum Case Accessories Introduction



Laser Clip



Scanning Clip



Assembly Line Clip



Pipe Clip



Edge Position Plate

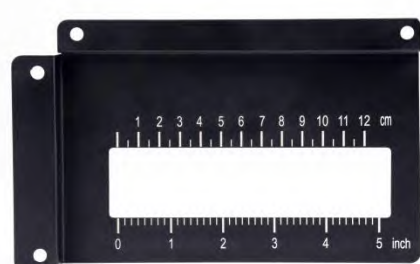

Printing Position Plate



Data Cable



USB Flash Drive



Imported Black
Ink Cartridge



Battery



Print Head
Protective Cover



Handheld
Inkjet Printer

After-Sales Warranty



**1-Year
Warranty**

Full Coverage of Manufacturing Defects



**Customer
Support**

Please email us, we are here to support you at all times.

info@printisian.com