

4^a Generazione Stampante Inkjet Portatile Modulare Multiuso



Moduli Integrati Multifunzione 1+N

Supporto A Tutte Le Operazioni Di Stampa



Touch Screen HD
Da 5 Pollici

HD
1280 X 720



Batteria
Sostituibile Da
3000 MAh



2 Formati Di Stampa
Disponibili

Max. 600 Mm



Sistema Di Stampa Personalizzato Intelligente

MFD:09/09/2022
EXP:09/09/2023

Data di
Produzione

MFD:09-09-2022
EXP:09-09-2023

Caratteri
Bitmap

PRINTISIAN
printisian
printisian

Caratteri Testuali
Personalizzati

TXT
≡

Testo

A000-1
A000-2
A000-3

Numero
di Serie

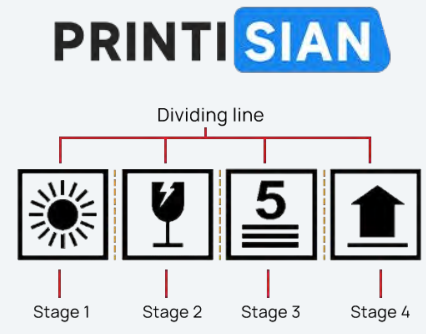

Logo
Nome Marchio



Codice a Barre

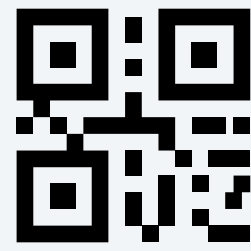

Codice QR



Grafiche

Item	DELLOLED	
Batch No	230721-B	
SN	001-08958	

Modelli File

Stampa Su Qualsiasi Materiale

Stampa su qualsiasi superficie

Liscia, ruvida, stretta...

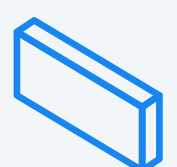

Stampa su qualsiasi forma

Superficie rotonda, curva, bordo sottile...

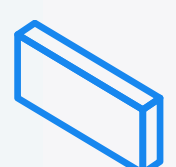
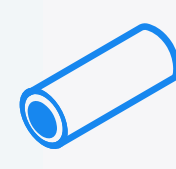

Stampa su qualsiasi materiale

Carta, vetro, cartone, plastica, metallo, legno, cemento, cavo, ruota, pelle...

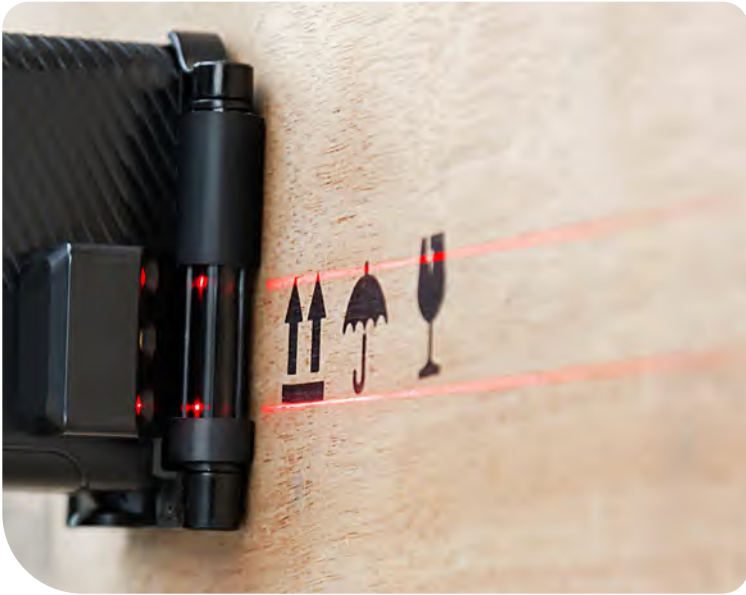

Design Modulare Flessibile

5 Adattatori Intercambiabili Liberamente - Infinite Possibilità

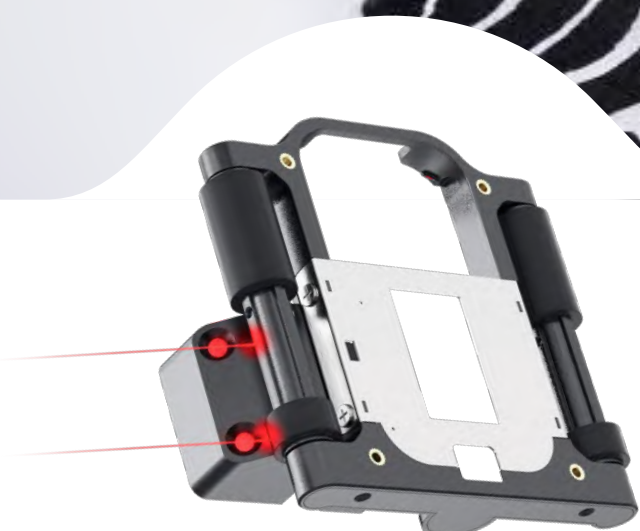

Clip di allineamento laser

Il puntatore laser migliora notevolmente precisione di posizionamento, efficienza e consistenza, per la massima produttività

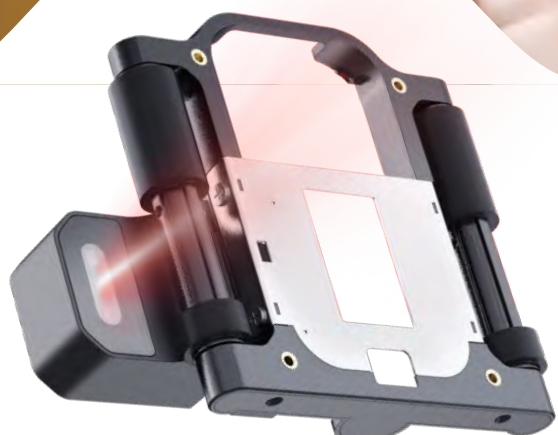

Clip scanner

Acquisizione di codici a barre e QR per stampa diretta. Il riconoscimento istantaneo ottimizza i flussi dalla cassa alla gestione di magazzino nel backend

Clip per linea di assemblaggio

Stampa automatica triggerata dal rilevamento linea. Risparmia cablaggio e messa in servizio, comodo ed efficiente



Clip per tubi

Doppia distanza ruote regolabile per stampa stabile su tubi di diametri diversi. Garantisce tracciabilità per tutte le applicazioni edili e legnose



Clip di posizionamento bordo

Stampa automatica triggerata dal rilevamento linea. Risparmia cablaggio e messa in servizio, comodo ed efficiente



Metodo Di Stampa Monostadio

Pronta In Soli 3 Semplici Passaggi

Metodo Di Stampa 1: Pronta In 3 Semplici Passaggi

Design



Touch



Scorri



Metodo 2: Stampa Senza Contatto

Sensore integrato per la stampa senza premere pulsanti



Settori Applicabili

Nuova Esperienza Per Tutti I Settori Industriali

Industria di imballaggio

Crea etichette specifiche per il settore per semplificare la tracciabilità e la gestione degli imballaggi

Fabbricazione industriale

Stampante portatile a getto d'inchiostro, utilizzo illimitato in qualsiasi posizione. Migliora l'efficienza della gestione materiali per i materiali difficilmente trasportabili

Studio creativo

Crea etichette DIY esclusive e dai vita alla tua creatività straordinaria

Industria articoli per la casa

Flessibile ed efficiente, compatibile con prodotti di diverse categorie

80m / Min

Veloce & Efficiente Velocità Di Stampa

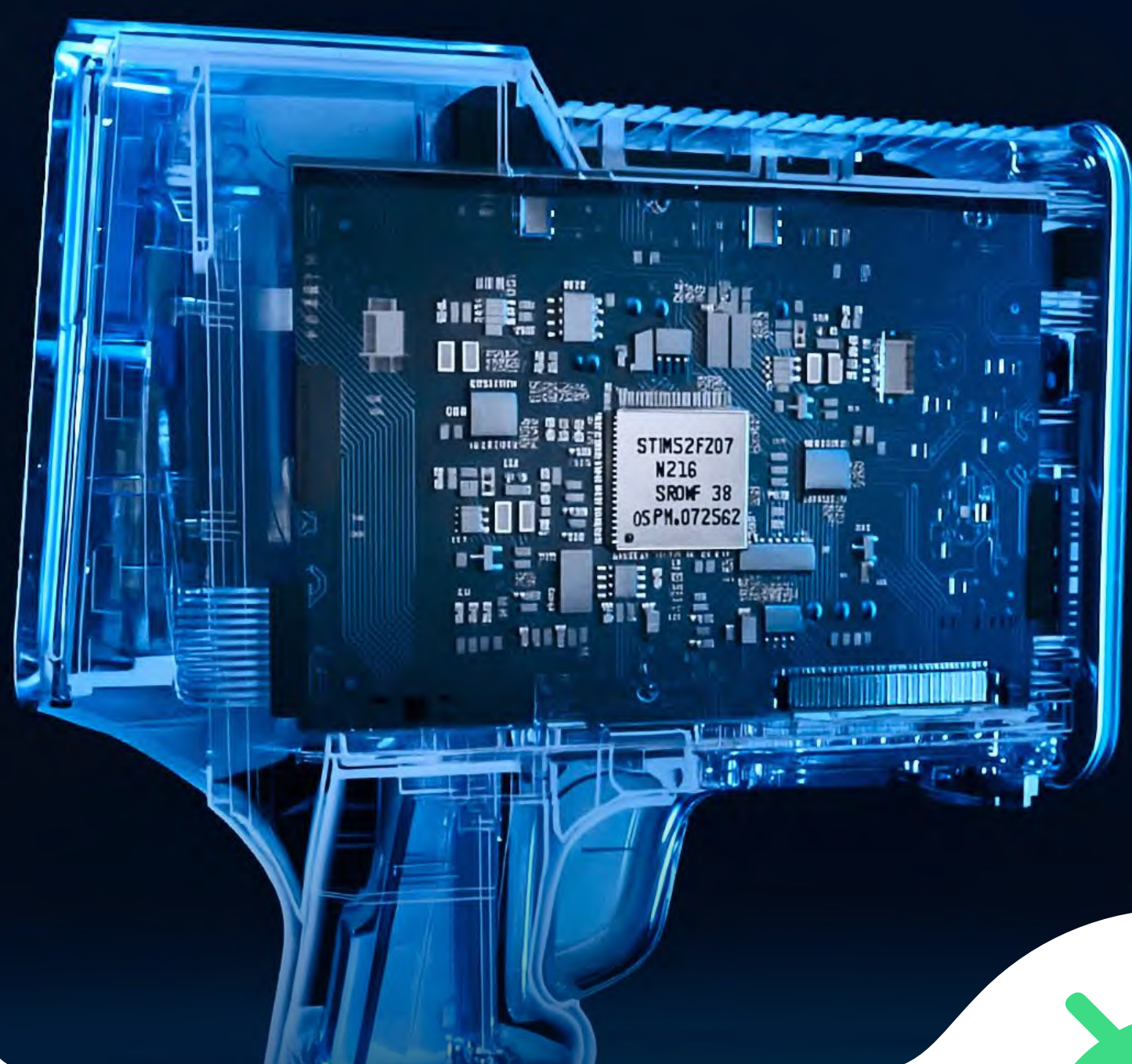

30%
Tasso di reazione medio

47%
Velocità di stampa
per attività complesse

1GB
RAM

8GB
ROM

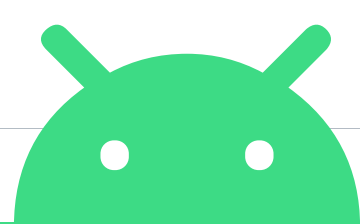

Sistema PrintOS Supporto Android completo

Supporto Multilingue



Supporto Di Immissioni Tastiera Personalizzabili



Impostazioni Caratteri



Caratteri multipli integrati

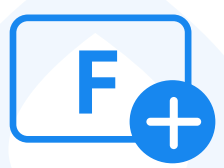

Importazione caratteri
personalizzati

Efficiente Formato grande Stampa grafica e testuale

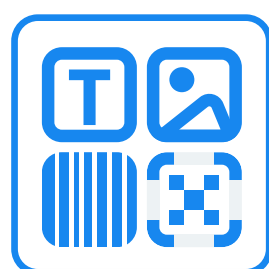

Attività di stampa salvate



Modulo di modifica informazioni



Cartucce Di Inchiostro Selezione Rapida



Selezione
dimensioni

Tipo inchiostro

Selezione colori

Colore invisibile

Selezione dimensioni

0.5" (12.7mm)

1" (25.4mm)

Tipo inchiostro

Tipo solvente

Tipo acquoso

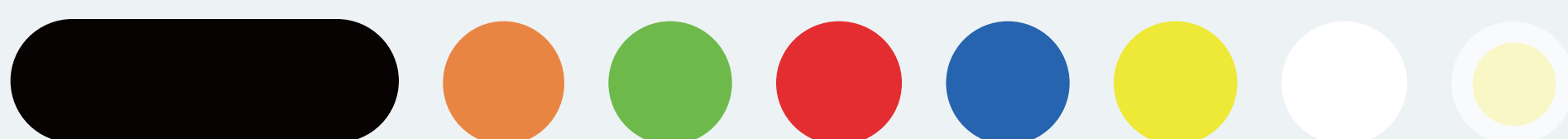

42ml

Altezza
stampa
0.5 pollici
(12.7mm)



45ml

Altezza
stampa
1 pollice
(25.4mm)



Effetto stampa cartucce



600 DPI
Bordi nitidi e
definiti

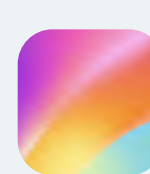

Dettagli eccellenti
Resa cromatica
naturale

Specifiche Prodotto

Parametri Stampante Inkjet Portatile

Dimensione	5,7×2×8,85 pollici (L×P×A 14,5×5,3×22,5 cm)
Peso	18oz (512g)
Display	Display Touch IPS-LCD Da 5 Pollici
Materiale	Materiale plastico ABS
USB	Type-C / USB-A
Metodo Di Stampa	Tasti / Sensori
Batteria	3000 mAh Autonomia di funzionamento continuativo 10 ore
Caricabatteria	5V/2A
Lunghezza Massima Stampa Singola	0,07-39,3 Pollici (2-1000 Mm)
Ambiente Di Funzionamento	Temperatura di funzionamento: 0°C a 40°C (32°F a 104°F) Umidità:10% -80%
Contenuto Di Stampa	Testo, Codici QR, Codici A Barre, Date, Grafiche, Tabelle Stampa Segmentata, Testo Variabile, Immagini Variabili, Codici QR Variabili, Codici A Barre Variabili
Supporto Lingue	

Parametri Cartucce Inchiostro

Colore	Nero, Rosso, Blu, Giallo, Viola
Peso	Cartuccia 0,5 Pollici: 3,9 Oz (113 G) Cartuccia 1 Pollici: 4,7 Oz (135 G)
Risoluzione	Cartuccia 0,5 Pollici: 300-600 DPI Cartuccia 1 Pollici: 300 DPI
Altezza Stampa Singola	Cartuccia 0,5 Pollici: 0,07-0,5 Pollici (2-12,7 Mm) Cartuccia 1 Pollici: 0,07-1 Pollici (2-25,4 Mm)
Distanza Di Stampa	0,07-0,19 Pollici (2-5 Mm)
Capacità Di Stampa Per Cartuccia	1531 Iarde (1400 M) Oppure 5000 Pagine (Copertura Del 5%)
Materiali Stampabili	Legno, Cartone, Tubi, Sacchetti In Plastica, Sacchetti In Alluminio, Ceramica, Vetro, Metallo, Pietra Materiali Da , Costruzione E Altri Materiali
Ambiente Di Funzionamento	Temperatura Di Funzionamento: 0°C A 40°C (32°F A 104°F) Umidità: 10% - 80%



Peso Netto Valigetta In Alluminio: **56,4 oz (1,6Kg)**

(Materiale esterno: struttura in lega di alluminio; Materiale interno: schiuma EVA)

Valigetta In Alluminio

Descrizione Accessori



Morsetto laser



Morsetto scanner



Morsetto di montaggio



Morsetto tubo



Piastra di posizionamento laterale

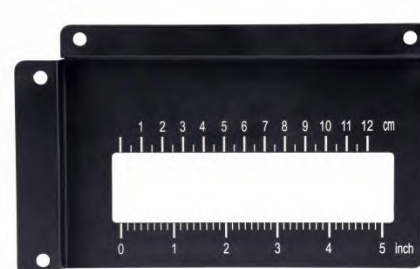

Piastra di posizionamento di stampa



Cavo dati



Chiavetta USB



Cartuccia di inchiostro nera importata



Batteria ricaricabile



Custodia protettiva per testina di stampa



Stampante a getto d'inchiostro

Garanzia Supplementare



Garanzia di 1 anno

Copertura completa dei difetti di fabbricazione



Assistenza clienti

Inviateci un'e-mail - vi assisteremo in qualsiasi momento

info@printisian.com